

Analog Devices Welcomes Hittite Microwave Corporation

NO CONTENT ON THE ATTACHED DOCUMENT HAS CHANGED



THIS PAGE INTENTIONALLY LEFT BLANK

Typical Applications

The HMC256 is ideal for:

- Microwave Radio & VSAT
- Test Instrumentation
- Military Radios Radar & ECM
- Space

Functional Diagram

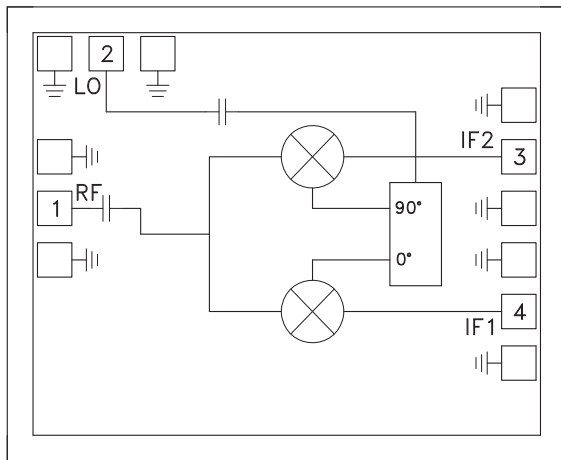

Features

- High Image Rejection: >30 dB
- Input IP3: +18 dBm
- Wideband IF: DC to 1.5 GHz
- Die Size: 1.6 x 1.3 x 0.1 mm

General Description

The HMC256 chip is a compact, 2.08 mm², I/Q Mixer MMIC which can be used as an Image Reject Mixer (IRM) or Single Sideband (SSB) upconverter. The chip utilizes two standard Hittite double-balanced mixer cells and a Lange Coupler realized in GaAs MESFET technology. All data is with the chip in a 50 Ohm test fixture connected via 0.025 mm (1 mil) diameter wire bonds of minimal length <0.51 mm (<20 mils). A low frequency quadrature hybrid was used to interface the MMIC IF ports to a 120 MHz IF USB output. This provides an example of the I/Q Mixer in an IRM application. The IF may be used from DC to 1.5 GHz. This I/Q Mixer is a more reliable, much smaller replacement to hybrid drop-in style I/Q Mixer assemblies.

Electrical Specifications, $T_A = +25^\circ \text{C}$, As an IRM

Parameter	IF = 70 - 200 MHz LO = +18 dBm			IF = 70 - 200 MHz LO = +15 dBm			Units
	Min.	Typ.	Max.	Min.	Typ.	Max.	
Frequency Range, RF	5.9 - 12			7.1 - 11.7			GHz
Frequency Range, LO	5.7 - 12			6.9 - 11.7			GHz
Frequency Range, IF	DC - 1.5			DC - 1.5			GHz
Conversion Loss		8	10.5		8	10.5	dB
Noise Figure (SSB)		8	10.5		8	10.5	dB
Image Rejection (IR)	24	32		20	30		dB
LO to RF Isolation	22	30		22	30		dB
LO to IF Isolation	27	35		27	35		dB
RF to IF Isolation	24	30		24	30		dB
IP3 (Input)		18			17		dBm
1 dB Gain Compression (Input)		5			5		dBm

Conversion Gain to Desired Sideband vs. Temperature @ LO = +15 dBm, IF = 120 MHz USB

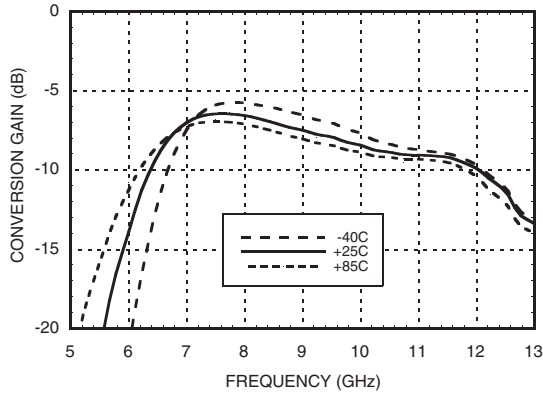

Conversion Gain to Desired Sideband vs. LO Drive, IF = 120 MHz USB

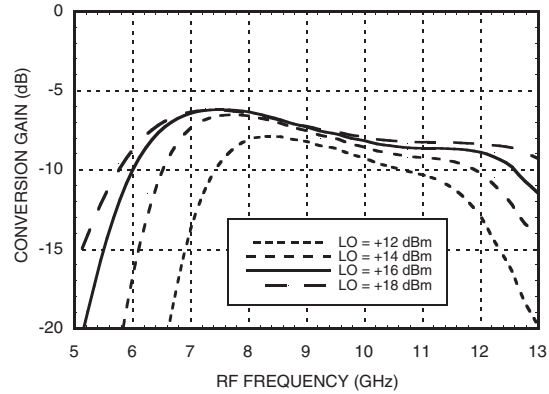

Image Rejection vs. Temperature LO = +15 dBm, IF = 120 MHz USB

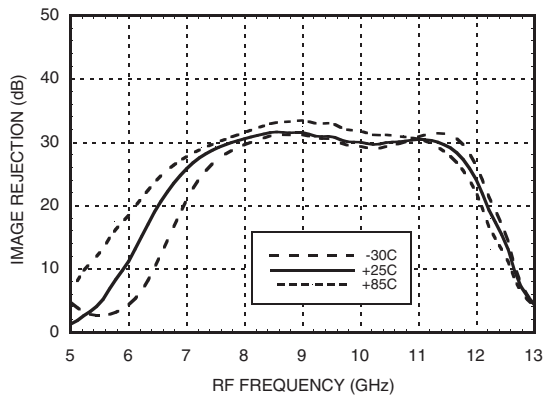
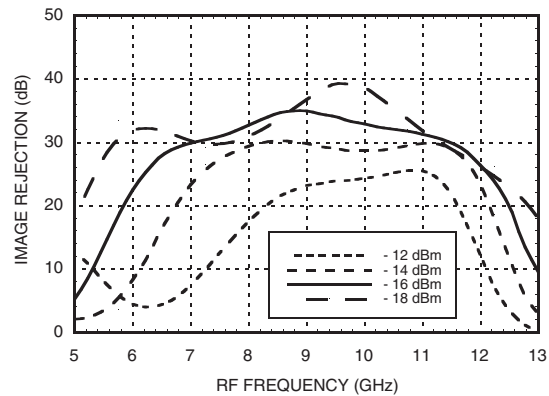
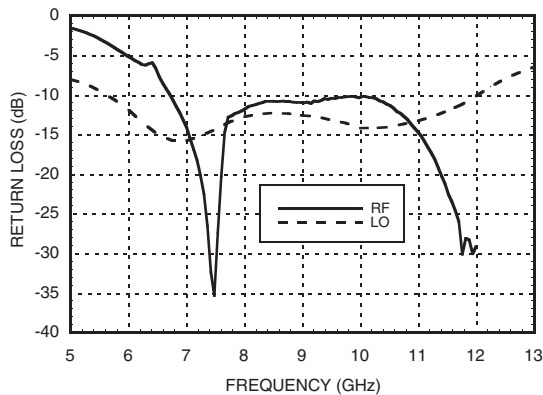

Image Rejection vs. LO Drive, IF = 120 MHz USB



Return Loss @ LO = +15 dBm



Isolations @ LO = +15 dBm

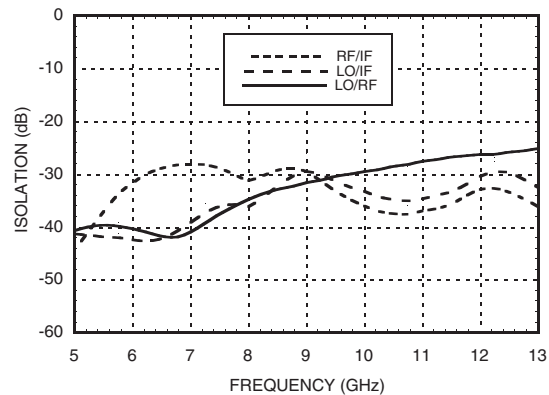

IF Bandwidth @ LO = 15 dBm

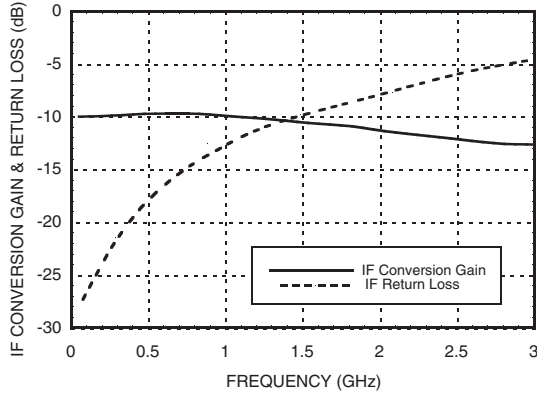

Input IP3 vs. LO Drive, IF = 120 MHz USB

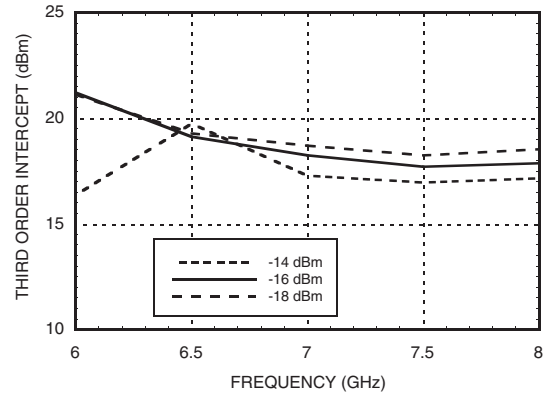

Absolute Maximum Ratings

RF / IF Input	+13 dBm
LO Drive	+27 dBm
Channel Temperature	150 °C
Continuous P _{diss} (T = 85 °C) (derate 9.36 mW/°C above 85 °C)	0.61 W
Thermal Resistance (R _{TH}) (junction to die bottom)	106.8 °C/W
Storage Temperature	-65 to +150 °C
Operating Temperature	-55 to +85 °C



**ELECTROSTATIC SENSITIVE DEVICE
OBSERVE HANDLING PRECAUTIONS**

Outline Drawing

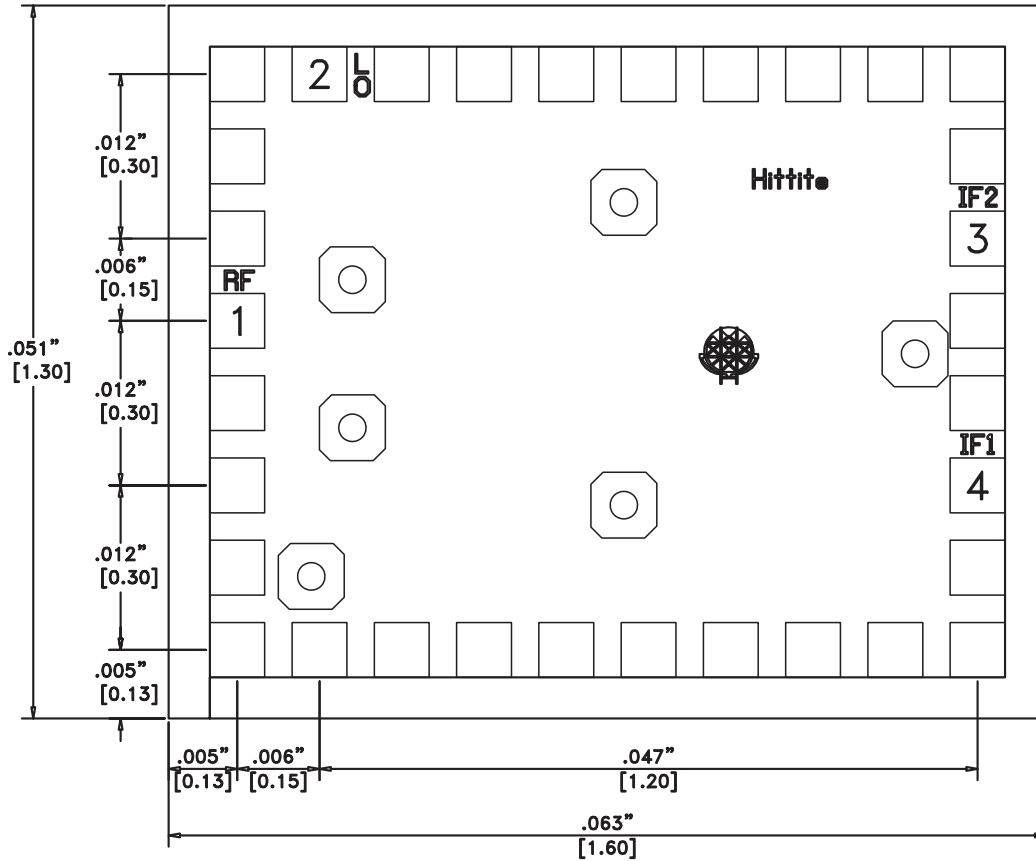

NOTES:

1. ALL DIMENSIONS ARE IN INCHES [MM].
2. BOND PADS ARE $.004''$ SQUARE.
3. TYPICAL BOND PAD SPACING CENTER TO CENTER IS $.006''$.
4. BACKSIDE METALLIZATION: GOLD.
5. BOND PAD METALLIZATION: GOLD.
6. BACKSIDE METAL IS GROUND.
7. CONNECTION NOT REQUIRED FOR UNLABELED BOND PADS.

Die Packaging Information ^[1]

Standard	Alternate
WP-3 (Waffle Pack)	[2]

[1] Refer to the "Packaging Information" section for die packaging dimensions.

[2] For alternate packaging information contact Hittite Microwave Corporation.

Pad Descriptions



Pad Number	Function	Description	Interface Schematic
1	RF	This pin is AC coupled and matched to 50 Ohm.	
2	LO	This pin is AC coupled and matched to 50 Ohm.	
3, 4	IF1, IF2	This pin is DC coupled. For operation to DC pin must not sink/source more than 2 mA of current or failure may result.	
Backside	GND	The backside of the die must connect to RF ground.	

Image Reject Mixer Suggested Application Circuit

Below in **Figure 1** is a photo and in **Figure 2** a schematic of the HMC256 image reject mixer MMIC die connected to a quadrature hybrid (120 MHz) manufactured by Merrimac Industries West Caldwell, NJ (P/N QHZ-2A-120).

Data presented for the HMC256 MMIC IRM was obtained using the circuit described here. Please note that the image rejection and isolation performance is dependent on the selection of the low frequency hybrid. The performance specification of the low frequency quadrature hybrid as well as the phase balance and VSWR of the interface circuit to the HMC256 MMIC will effect the overall IRM performance.

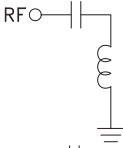
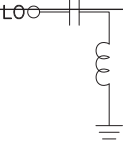
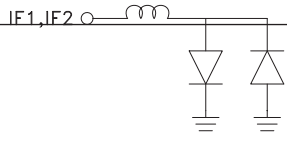
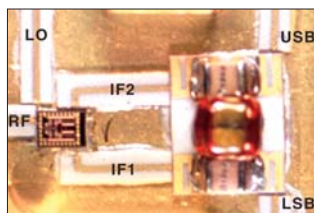

Figure 1:
Complete MIC IRM Assembly

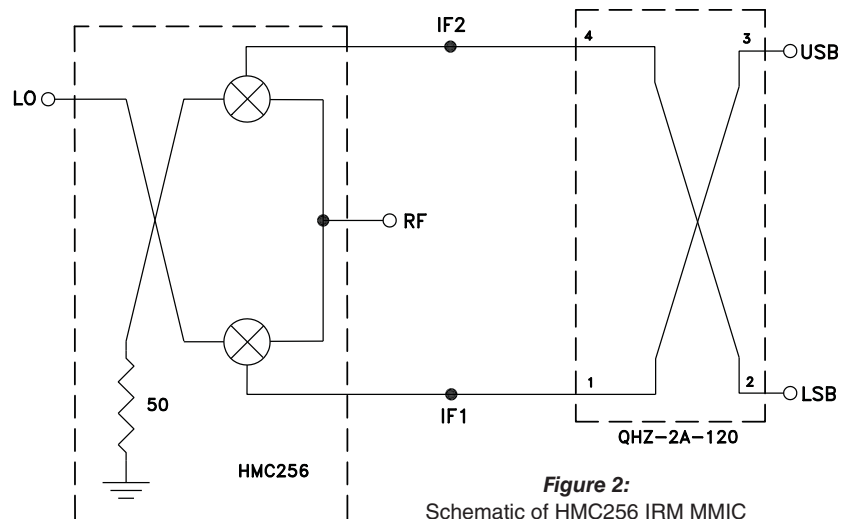

Figure 2:
Schematic of HMC256 IRM MMIC
Connected to the Quadrature Hybrid

Handling Precautions

Follow these precautions to avoid permanent damage.

Storage: All bare die are placed in either Waffle or Gel based ESD protective containers, and then sealed in an ESD protective bag for shipment. Once the sealed ESD protective bag has been opened, all die should be stored in a dry nitrogen environment.

Cleanliness: Handle the chips in a clean environment. DO NOT attempt to clean the chip using liquid cleaning systems.

Static Sensitivity: Follow ESD precautions to protect against ESD strikes.

Transients: Suppress instrument and bias supply transients while bias is applied. Use shielded signal and bias cables to minimize inductive pick-up.

General Handling: Handle the chip along the edges with a vacuum collet or with a sharp pair of bent tweezers. The surface of the chip has fragile air bridges and should not be touched with vacuum collet, tweezers, or fingers.

Mounting

The chip is back-metallized and can be die mounted with AuSn eutectic preforms or with electrically conductive epoxy. The mounting surface should be clean and flat.

Eutectic Die Attach: A 80/20 gold tin preform is recommended with a work surface temperature of 255 °C and a tool temperature of 265 °C. When hot 90/10 nitrogen/hydrogen gas is applied, tool tip temperature should be 290 °C. DO NOT expose the chip to a temperature greater than 320 °C for more than 20 seconds. No more than 3 seconds of scrubbing should be required for attachment.

Epoxy Die Attach: Apply a minimum amount of epoxy to the mounting surface so that a thin epoxy fillet is observed around the perimeter of the chip once it is placed into position. Cure epoxy per the manufacturer's schedule.

Wire Bonding

Ball or wedge bond with 0.025 mm (1 mil) diameter pure gold wire. Thermosonic wirebonding with a nominal stage temperature of 150 °C and a ball bonding force of 40 to 50 grams or wedge bonding force of 18 to 22 grams is recommended. Use the minimum level of ultrasonic energy to achieve reliable wirebonds. Wirebonds should be started on the chip and terminated on the package or substrate. All bonds should be as short as possible <0.31 mm (12 mils).